



POLYGON LASER SCANNERS QUICK REFERENCE TABLE

LIST OF TYPICAL MODELS

Model Item	PD30LA 	PD60EA 	PD60SRB 	PD60LA 	PT60SRG 	PT22ERG 	PTC30ERG 	
Bearing structure	Ball bearing	Ball bearing	Ball bearing	Ball bearing	Air bearing	Air bearing	Air bearing	
Mirror size Number of facets*Inscribed circle diameter*Thickness(mm)	6 × φ 40 × 3	8 × φ 55 × 6	16 × φ 84 × 9	6 × φ 65 × 12	18 × φ 65 × 4	6 × φ 26 × 3	8 × φ 40 × 2	
Flatness (Wave length λ= 632.8 nm)	λ / 4	λ / 6	λ / 4	λ / 5	λ / 4	λ / 4		
Reflectivity Wave length:λ Incident angle: i = 30°	85 % minimum λ = 780 nm	85 % minimum λ = 685 nm	85 % minimum λ = 780 nm	85 % minimum λ = 632.8 nm	85 % minimum λ = 632.8 nm	85 % minimum λ = 780 nm	85 % minimum λ = 780 nm	
Speed range(r/min)	1500~2000	1500~5000	15000	1500~5000	27000	20000~50000	20000~60000	
Dynamic pyramidal angle error Peak-peak / Adjacent(s)	120 / 60	60 / 30	60 / 30	20 / 10	80 / 40	90 / 60	90 / 60	
Jitter P-P (%) / RF (%)	0.04 / 0.02	0.03 / 0.015	0.03 / 0.015	0.018 / 0.01	0.02 / 0.01	0.03 / 0.02	0.03 / 0.02	
Supply voltage(V)	24						24~28	
Startup current(A)	0.6	0.1	2.0	3.0	4.0	2.0	2.0	
Operating current(A)	0.4	0.6	1.0	0.7	2.0	1.0	1.0	
Startup up time(s)	12	30	30	30	30	6.0	10	

PD60SRG/PT22ERG

POLYGON LASER SCANNERS

■ TYPICAL OUTLINE DIMENSIONS (SCANNER ASSEMBLY)

Unless otherwise specified, tolerance : ± 0.5 (Unit : mm)

PT60SRG

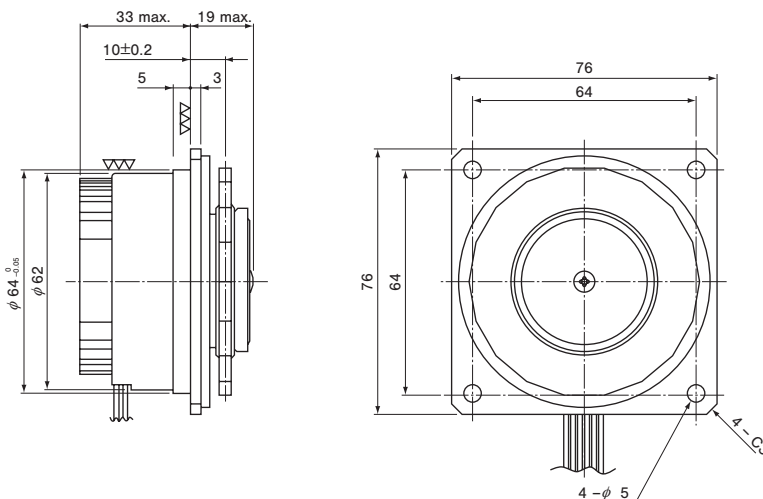
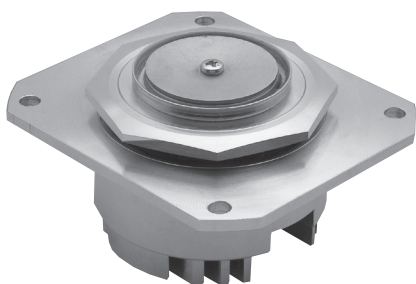

PT22ERG

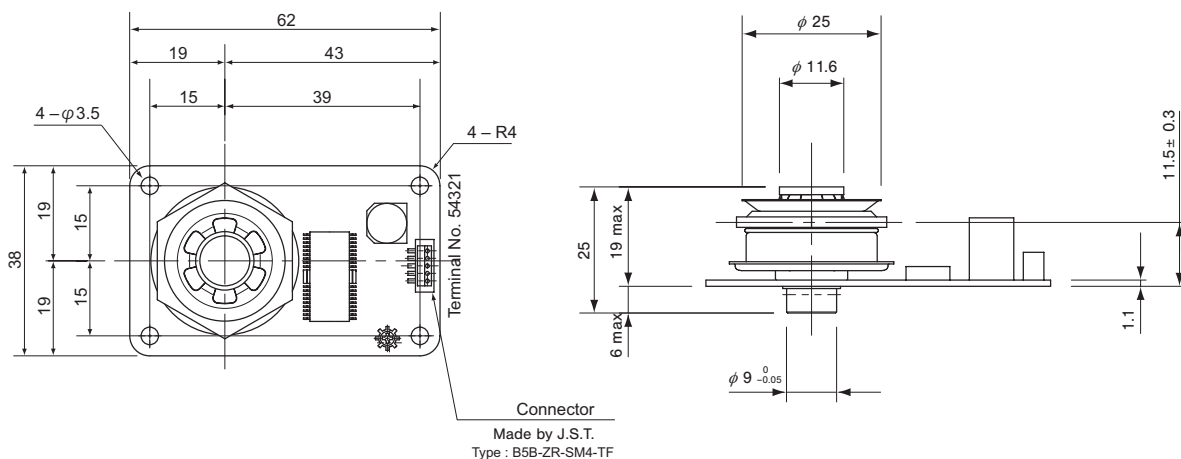
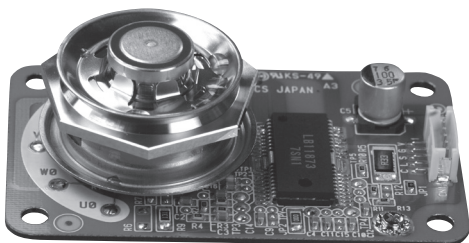

**POLYGON LASER SCANNERS listed here are typical value.
All our production will be made upon receipt of your order.
Please contact your sales agent for details.**