

# PRESSURE SWITCHES

# PS20

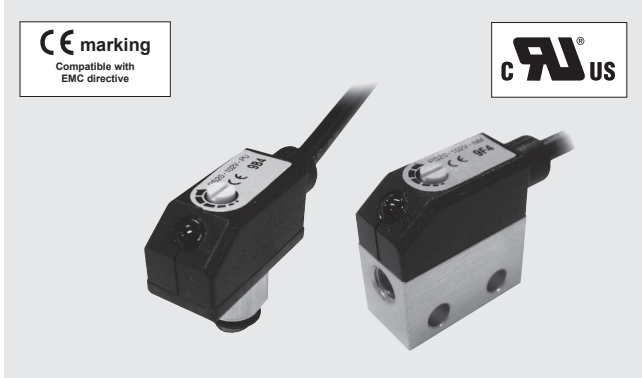

## FEATURES

- Ultra-small size pressure transducer with Amp.
- With 1 switch output
- 2 types of pressure ports are available
- Meet EMC standards

**INTERNAL STRUCTURE**  
(2-M5 female screw)

Part name	Material
① Pressure port	Aluminum
② Housing	PC (Polycarbonate)
③ Sensor module	PPS (Polyphenylenesulphide)
④ "O" ring	Fluoro-rubber
⑤ Cable	Vinyl chloride resin
⑥ VR	POM (polyoxymethylene)

## MODEL NUMBER DESIGNATION

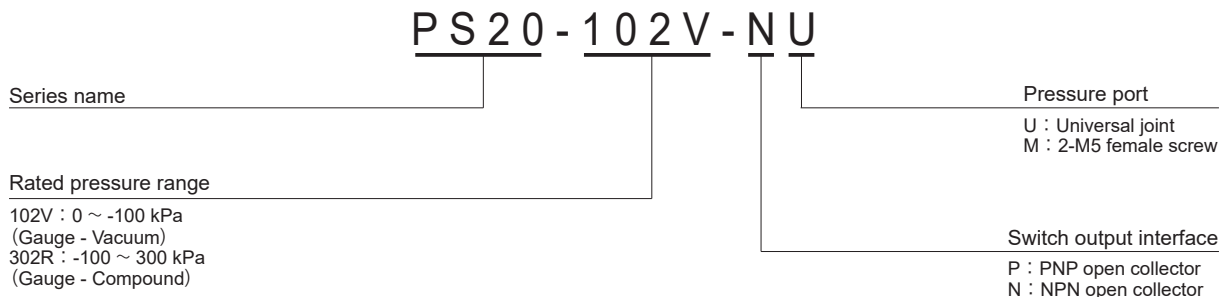

## LIST OF MODEL NUMBERS

Pressure port	Pressure reference	Rated pressure range [kPa]	
		0 ~ - 100	- 100 ~ 300
Universal joint	NPN	PS20-102V-NU	PS20-302R-NU
	PNP	PS20-102V-PU	PS20-302R-PU
2-M5 female screw	NPN	PS20-102V-NM	PS20-302R-NM
	PNP	PS20-102V-PM	PS20-302R-PM

※ Verify the above model numbers when placing orders.

# PS20 PRESSURE SWITCHES

## STANDARD SPECIFICATIONS

● Unless otherwise specified, the specs are defined at an ambient temperature of 25±5 °C and excitation voltage of 24 VDC.

Item	Model number	PS20		
		102V	302R	
General specifications	Pressure reference	Gauge		
	Rated pressure range	kPa	0 ~ - 100	- 100 ~ 300
	Maximum pressure	kPa	200	600
	Operating temp. range	°C	- 10 ~ 60	
	Compensated temp. range	°C	0 ~ 50	
	Operating humidity	%RH	35 ~ 85	
	Storage temp.	°C	- 20 ~ 70	
	Pressure medium		Non-corrosive gases	
	Insulation resistance	MΩ minimum	100	
	Dielectric strength		500 VAC, 60 s	
	Net weight (Without cable)	g	Approx. 4 (PS20- * * * * - * U) 7 (PS20- * * * * - * M)	
Power	Supply voltage	VDC	10.8 ~ 30 (Including ripple percentage)	
	Consumption current	maximum	20 mA	
Switch output	No. of output		1	
	Output interface		NPN/PNP open collector output	
	Setting method		Adjustable by VR	
	Adjustable range		Zero through rated pressure, minimum	
	Display		Red LED (lighted when output is ON.)	
	Accuracy 0 ~ 50 °C (Reference temp.: 25 °C)	% F.S.	± 3	
	Hysteresis	% F.S. maximum	2	
	Switching capacity		30 VDC 80 mA maximum	
	Residual voltage	V	0.8 (NPN), 1.8 (PNP)	
Response	ms	Approx. 1		

## ENVIRONMENTAL CHARACTERISTICS

Test item	Test conditions	Permissible change
Vibration	10 ~ 55 Hz, 1.5 mm maximum, 3 directions for 2 hours each	Switch output pressure : ± 2 %F.S., maximum after test
Shock	1000 m/s <sup>2</sup> , 3 directions for 3 times each	
Pressure cycling	0 ~ Rated pressure, 10 <sup>6</sup> cycles	
Moisture resistance	40 °C, 90 ~ 95 %RH, 240 hrs.	

# PS20

## PRESSURE SWITCHES

### OUTLINE DIMENSIONS

Unless otherwise specified, tolerance : ± 0.5 (Unit: mm)

#### Universal joint type

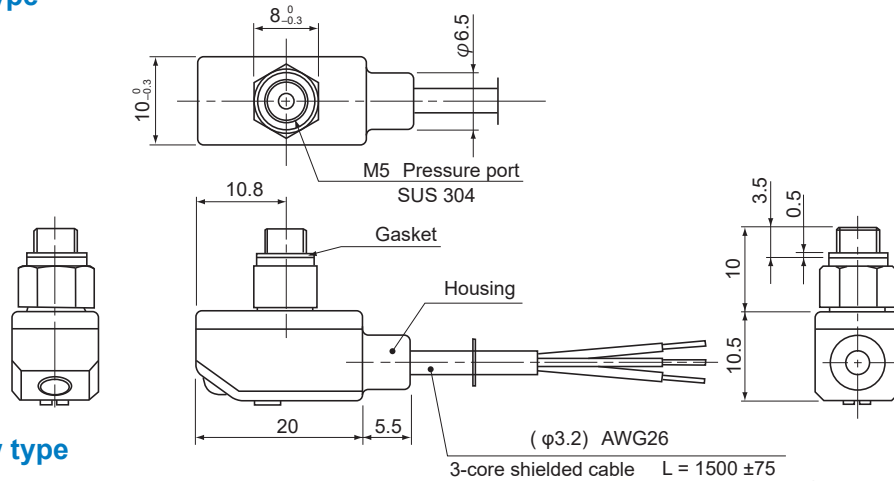

#### M5 female screw type

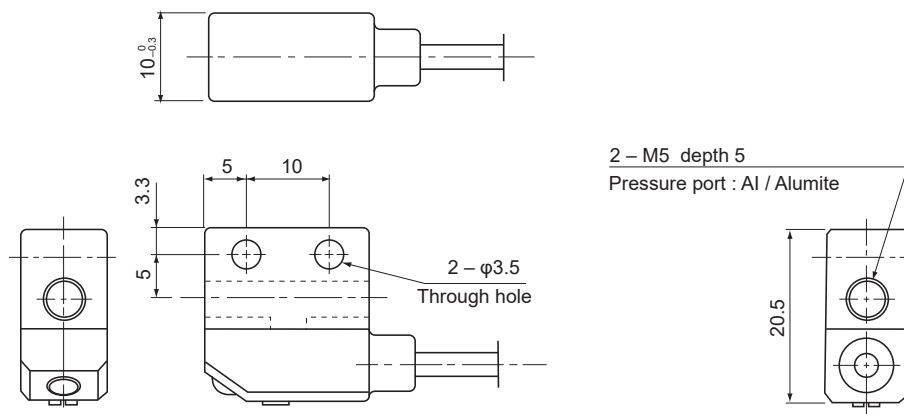

PS20

Wire color	Connection
Brown	Power ⊕
Black	Switch output
Blue	Common

### INTERNAL ELECTRICAL SCHEMATICS

#### NPN open collector

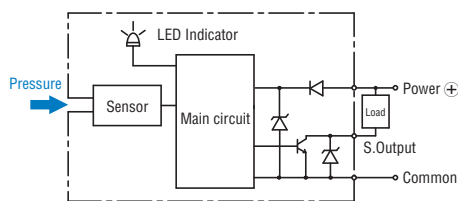

#### PNP open collector

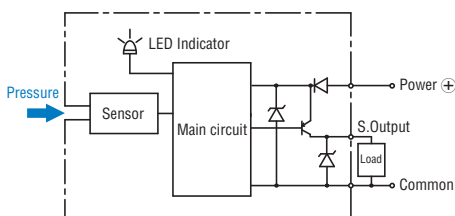

### SWITCH OUTPUT SCHEMATICS

Turns on at the set pressure and turns off at the set pressure minus the hysteresis.

#### 102V

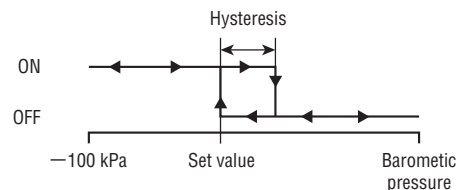

#### 302R

