

8 Series Pushbutton Switches

■ Features

1. Contacts

Silver or gold-plated contacts.

2. Epoxy resin case

UL94V-0 self-extinguishing epoxy.

3. Actuator style

Over 30 actuator variations.

4. Insulation between terminal and ground: 4 mm minimum.

5. Prevention of flux entry

The epoxy resin seal on bottom of the switch helps prevent the entry of solder and flux.

6. Insulation barrier:

Insulation barrier design between poles helps prevent short-circuiting between poles ensuring high reliability.

■ Specifications

Rating	Max. rating	6A 125 VAC/3A 250 VAC/4A 30 VDC(Resistive load)	
Initial contact resistance	10 mΩ max. (1A 2~4 VDC)		
Initial dielectric strength	1,500 VAC 1 minute		
Initial insulation resistance	1,000 MΩ min. (500 VDC)		
Electrical life (Excluding 8R & 8W)	Alternate type	40,000 operations	
	Momentary type	25,000 operations	
Operating temperature range	-30°C~+85°C		
Storage temperature range	-40°C~+85°C		

(Excluding 8R & 8W.)

■ Terminal Styles

Solder (Style:1)	PC Straight (Style:2)

Even if the products are of UL-or CSA-approved ones, The products in stock do not carry the UL mark of the CSA mark. When placing an order, be sure to specify "With UL/CSA Mark." For the products with the UL mark or the CSA mark, extra costs will be added.

**UL-Recognized, CSA certified Products
(Pushbutton type Only)**







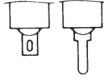

■ Eight Switch Series

Poles	Switching function	UL (※2.)			CSA (※3.)		
		8N	8P	8Y	8N	8P	8Y
1 pole	1011-Z ON - ON	○	○	○	○	○	○
	1021-Z ON -(ON)	○	○	○	○	○	○
	1022-Z	○			○		
2 poles	2011-Z ON - ON	○	○	○	○	○	○
	2012-Z	○			○		
	2022-Z ON -(ON)	○	○	○	○	○	○
3 poles	3011-Z ON - ON	○		○	○		○
	3021-Z ON -(ON)	○		○	○		○
4 poles	4011-Z ON - ON	○			○		
	4021-Z ON -(ON)	○			○		

(※2.) UL File No.E43275

(※3.) CSA File No.LR38341

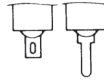
8 Series Pushbutton Switches Selection Table

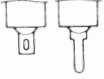
Part No.	Name	Actuator shape	Number of poles	Switching function	Terminal style	Page
8N	Standard Pushbutton		1.2.3.4	ON - ON ON - (ON)	 S/D Solder P/C Straight	239
8P	Splash Proof Pushbutton		1.2	ON - ON ON - (ON)	 S/D Solder	242
8Y	Mustang Pushbutton		1.2.3	ON - ON ON - (ON)	 S/D Solder	245
8R-N	Soft Touch Pushbutton		1.2	ON - ON ON - (ON)	 S/D Solder P/C Straight	248
8W-N	Snap-in Pushbutton		1.2	ON - (ON)	 S/D Solder P/C Straight	251

Part Numbering

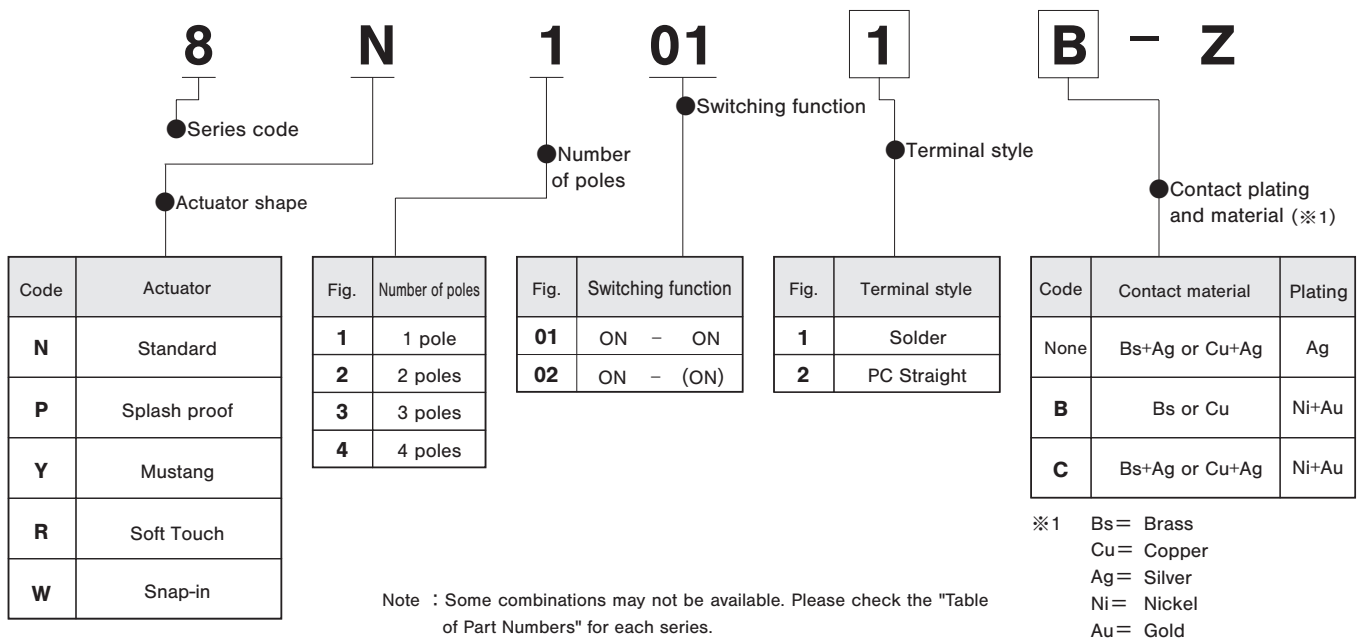

8N

Standard Pushbutton Switches

RoHS Compliant



Features

The 8N standard pushbutton switch is the basic type of "8" Series. Momentary and alternate functions are available. Color button is available in 8mm, 10mm and 15mm diameter and in 4 colors.

Table of Part Numbers

Terminal style	No. of pole Switching function	1 pole	2 poles	3 poles	4 poles
		Solder Lug	ON - ON 8N1011-Z	☆ 8N2011-Z	★ 8N3011-Z
	ON - (ON)	8N1021-Z ▲ 8N1021C-Z	8N2021-Z	★ 8N3021-Z	★ 8N4021-Z
PC Straight	ON - ON	—	★ 8N2012-Z	—	—
	ON - (ON)	☆ 8N1022-Z	☆ 8N2022-Z	—	—

Standard Accessories

《Supplied with switch》

Hex Nut	Lockwasher	Locking Ring
140008010241	140008030051	140008020062
Nickel plated	Zinc plated	Zinc plated

Color Button Mounting

Snap in the color button on to the actuator.

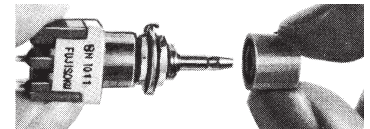

Part name	Color Button			
Dimension A	φ8	φ10	φ15	
Dimension B	7.5	8	10	
 (Material: PA)	White	140000481420	140000480082	140000480088
	Red	140000481421	140000480083	140000480089
	Black	140000481422	140000480081	140000480090
	Gray	140000481423	140000480084	140000480091

★ : Made to order products. ☆ : Semi-standard products. ▲ : Inquiry products. (ON) : Momentary.

● Hex Nut (2 pcs), Lockwasher (1 pc), and Locking Ring (1 pc) are supplied with the switch. A Color Button is also supplied with the switch. Please specify the part number from the above table when ordering.

SPDT

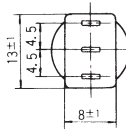
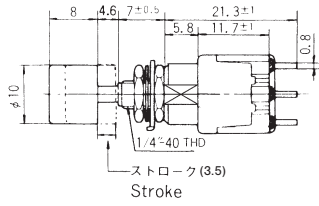
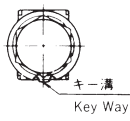

Terminal numbers are not shown on the switch.

Switching function		
Part No.		
※ 8N101■-Z	ON	ON
8N102■-Z	ON	(ON)
Connecting terminals	2-3	2-1

※ : The circuit switches each time the switch button is pressed.

■ : Please refer to "Table of Part Numbers" for a list of full part numbers.

DPDT

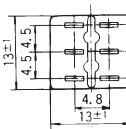
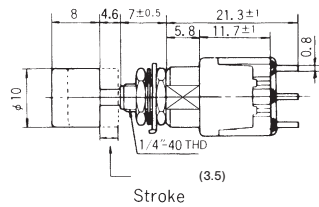
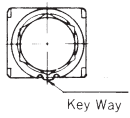

Terminal numbers are not shown on the switch.

Switching function		
Part No.		
※ 8N201■-Z	ON	ON
8N202■-Z	ON	(ON)
Connecting terminals	2-3 5-6	2-1 5-4

※ : The circuit switches each time the switch button is pressed.

■ : Please refer to "Table of Part Numbers" for a list of full part numbers.

3PDT

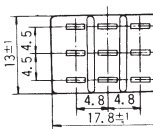
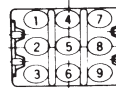
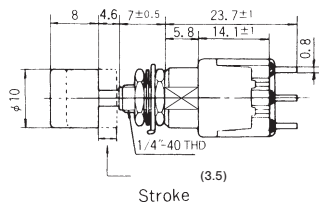
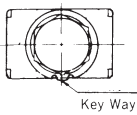
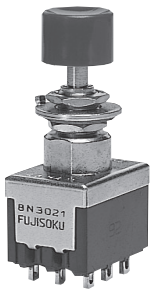

Terminal numbers are not shown on the switch.

Switching function		
Part No.		
※ 8N301■-Z	ON	ON
8N302■-Z	ON	(ON)
Connecting terminals	2-3 5-6 8-9	2-1 5-4 8-7

※ : The circuit switches each time the switch button is pressed.

■ : Please refer to "Table of Part Numbers" for a list of full part numbers.

4PDT

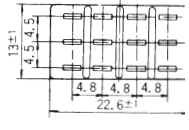
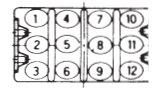
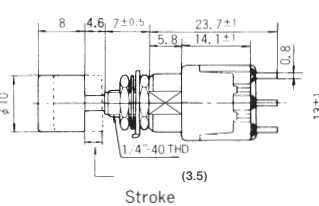
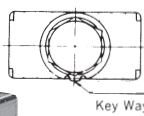
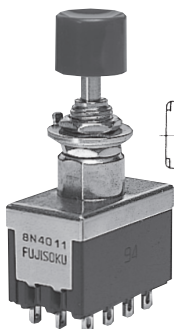

Terminal numbers are not shown on the switch.

Switching function		
Part No.		
※ 8N401■-Z	ON	ON
8N402■-Z	ON	(ON)
Connecting terminals	2-3 5-6 8-9 11-12	2-1 5-4 8-7 11-10

※ : The circuit switches each time the switch button is pressed.

■ : Please refer to "Table of Part Numbers" for a list of full part numbers.

Panel Cut-Out Dimensions

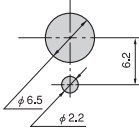
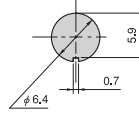
Series	8N	
Panel thickness	1.5 mm Max.	2.5 mm Max.
Dimensions	 <p>With Locking Ring</p>	 <p>Without Locking Ring</p>

PC Hole Layouts

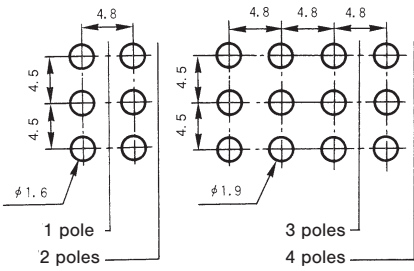
Series	8N
Dimensions	

Precautions

1. Soldering Specifications

(1) Manual soldering

Device : Solder iron

① 420°C Max. 3 sec. Max.

(2) Auto soldering

② 275°C ±10°C 5 sec. Max.

The above-stated soldering conditions shall apply only to switches with straight terminals. Auto soldering is not possible with right-angle terminals. Switches with right-angle terminals should be soldered manually according to the conditions specified in (1) above.

(3) When putting the switches through an aging process after they were soldered onto the printing board or after installed into a complete end product, be sure to remove the buttons of the switches.

2. Mounting

- Do not bend the terminals before mounting the switch on the PC board.
- After mounting the switch, do not place the device in such a way that the device weight will be applied on to the actuator of the switch.
- For switches with straight terminals, solder the switch on the PC board after fixing the switch on the panel with a nut.

3. Flux Cleaning

(1) Solvent : Fluorine or Alcohol type.

(2) 8 series are not washable. To wash the PC board, clean the soldering surface of the PC board with a brush so that the switch is not exposed to the cleaning solution.

Packaging Specification

