

ROTARY SELECTOR SWITCHES

SS-10/S-2050

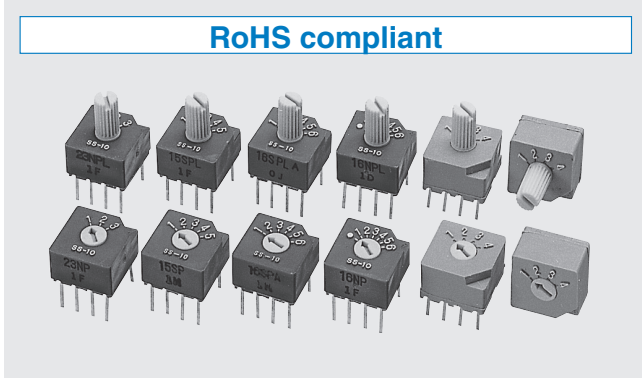

FEATURES

- RoHS compliant
- Compact-size DIP pin configuration
- Protected against dust and washable after soldering
- Self-cleaning mechanism

INTERNAL STRUCTURE
SS-10 series

Part name	Material	Flammability
① Rotor	Polyoxymethylene	UL94HB
② "O" ring	Silicone rubber	
③ Base	Polybutyleneterephthalate	
④ Terminal pin	Copper alloy, Gold-plated	—
⑤ Contact	Copper alloy, Gold-plated	
⑥ P.C.B.	Gold-plated epoxy board	
⑦ Housing	Polybutyleneterephthalate	UL94HB

PART NUMBER DESIGNATION

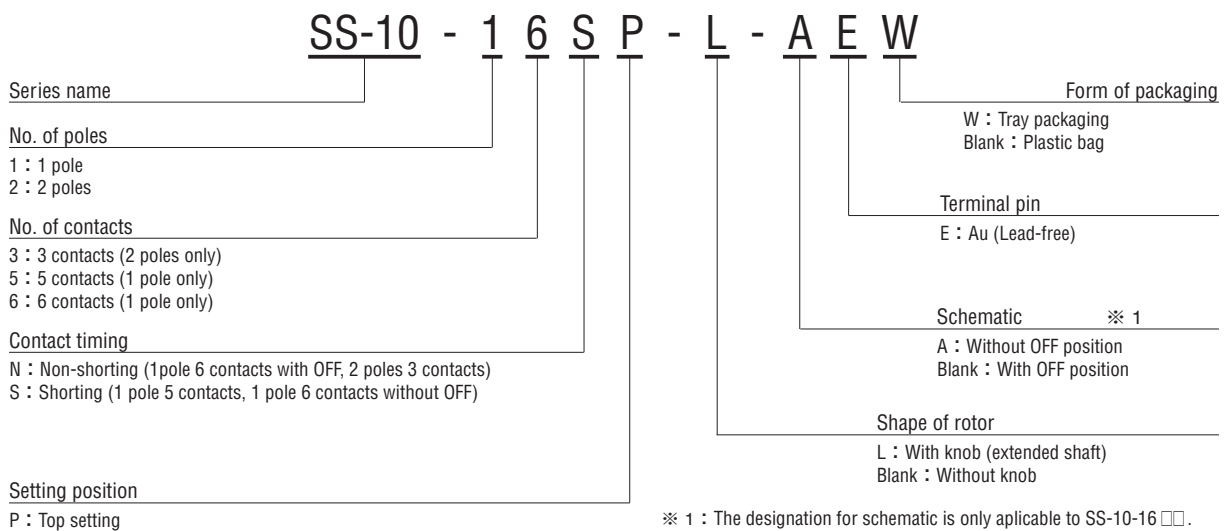

※ 1 : The designation for schematic is only applicable to SS-10-16□□.
The other partnumbers (ex. S-2050, SS-10-15SPEW) are without OFF position.

※ Please refer to the LIST OF PART NUMBERS when placing orders.

SS-10/S-2050

ROTARY SELECTOR SWITCHES

LIST OF PART NUMBERS

Circuit type	Shape		Form of packaging	Contact timing		Pieces in package	
				Non-shorting	Shorting		
1 pole 4 contacts	Top setting	Without knob	Tray packaging	S-2050W		50 pcs./tray	
			Plastic bag	S-2050		25 pcs./pack	
		With knob	Tray packaging	S-2150W		50 pcs./tray	
			Plastic bag	S-2150		25 pcs./pack	
	Side setting	Without knob	Tray packaging	S-2051W		50 pcs./tray	
			Plastic bag	S-2051		25 pcs./pack	
	With knob	Tray packaging	S-2151W		50 pcs./tray		
		Plastic bag	S-2151		25 pcs./pack		
1 pole 5 contacts	Top setting	Without knob	Tray packaging		SS-10-15SP-EW	50 pcs./tray	
			Plastic bag		SS-10-15S-PE	25 pcs./pack	
		With knob	Tray packaging		SS-10-15SP-L-EW	50 pcs./tray	
			Plastic bag		SS-10-15SP-L-E	25 pcs./pack	
1 pole 6 contacts		With OFF	Without knob	Tray packaging	SS-10-16NP-EW		50 pcs./tray
				Plastic bag	SS-10-16NP-E		25 pcs./pack
			With knob	Tray packaging	SS-10-16NP-L-EW		50 pcs./tray
				Plastic bag	SS-10-16NP-L-E		25 pcs./pack
	Without OFF	Without knob	Tray packaging		SS-10-16SP-AEW	50 pcs./tray	
			Plastic bag		SS-10-16SP-AE	25 pcs./pack	
	With knob	Tray packaging		SS-10-16SP-L-AEW	50 pcs./tray		
		Plastic bag		SS-10-16SP-L-AE	25 pcs./pack		
2 poles 3 contacts	Top setting	Without knob	Tray packaging	SS-10-23NP-EW		50 pcs./tray	
			Plastic bag	SS-10-23NP-E		25 pcs./pack	
		With knob	Tray packaging	SS-10-23NP-L-EW		50 pcs./tray	
			Plastic bag	SS-10-23NP-L-E		25 pcs./pack	

☐: Not manufactured

※ Verify the above part numbers when placing orders.

Tray version can be supplied only in tray nuts.

SCHEMATIC DIAGRAMS

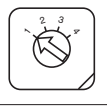
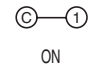
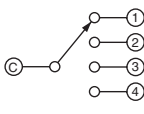

1 pole 4 contacts

Series	Switching specifications	Schematic
S-2050 S-2051 S-2150 S-2151	  ON	

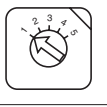
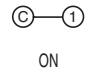
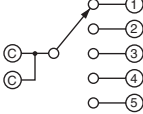

1 pole 5 contacts

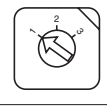
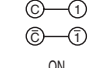
Series	Switching specifications	Schematic
SS-10-15SP-E SS-10-15SP-L-E	  ON	

2 poles 3 contacts

Series	Switching specifications	Schematic
SS-10-23NP-E SS-10-23NP-L-E	  ON	

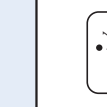
1 pole 6 contacts (With OFF)

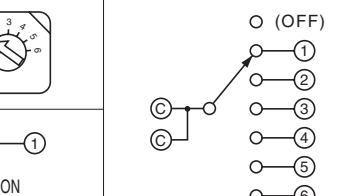
Series	Switching specifications	Schematic
SS-10-16NP-E SS-10-16NP-L-E	  ON	

1 pole 6 contacts (Without OFF)

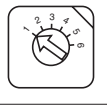
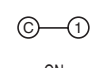
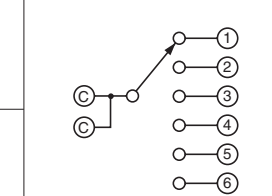
Series	Switching specifications	Schematic
SS-10-16SP-AE SS-10-16SP-L-AE	  ON	

SS-10/S-2050 ROTARY SELECTOR SWITCHES

TERMINAL CONNECTION / P.C.B. THROUGH HOLE DIMENSIONS (Unit: mm)

	SS-10-15	SS-10-16	SS-10-23	S-2050 S-2150	S-2051 S-2151
Terminal pin layout (Bottom view)					
P.C.B. dimensions (Bottom view)	Dimension is common to SS-10-15, SS-10-16 and SS-10-23 series. 				

STANDARD SPECIFICATIONS

Circuit type	1 pole 4 contacts 1 pole 5 contacts 1 pole 6 contacts 2 poles 3 contacts
Operating temperature range	- 25 ~ 70 °C
Storage temperature range	
Sealing	Washable by "O" ring ※ Please refer to page 150, 151
Net weight	Approx. 0.84 g (without knob) Approx. 0.94 g (with knob)

ELECTRICAL CHARACTERISTICS

Contact rating Non-switching Switching Minimum	DC50 V 100 mA DC5 V 100 mA DC20 mV 1 μ A
Contact timing	Shorting Non-shorting
Contact resistance	100 m Ω maximum
Insulation resistance	100 M Ω (DC100 V) minimum
Dielectric strength	AC300 V, 60 s

MECHANICAL CHARACTERISTICS

No. of positions	3, 4, 5, 6
Adjustment torque	40 mN·m {408 gf·cm} maximum
Stopper strength	50 mN·m {510 gf·cm} minimum
Stepping angle	36° (1 pole 4 contacts) 2 poles 3 contacts) 30° (1 pole 5 contacts) 22.5° (1 pole 6 contacts, with OFF) 28° (1 pole 6 contacts, without OFF)
Terminal strength	15 N {1.53 kgf} minimum
Solderability	245 \pm 3 °C, 2 ~ 3 s
Soldering heat	Flow soldering 260 \pm 3 °C, 5 ~ 6 s, two times maximum Manual soldering 380 \pm 10 °C, 3 ~ 4 s

ENVIRONMENTAL CHARACTERISTICS

Vibration	(Amplitude) 1.5 mmor (Acceleration) 98 m/s ² , 10-500-10 Hz, 3 directions for 2 h each
Shock	490 m/s ² , 11 ms 6 directions for 3 times each
Humidity (Steady state)	40 °C, Relative humidity 90 ~ 95 %, 240 h
Load life	500 cycles minimum DC5 V, 100 mA
High temperature exposure	70 °C, 240 h
Low temperature exposure	- 25 °C, 96 h
Thermal shock	- 25 (0.5 h) ~ 70 °C (0.5 h), 5 cycles

{ } : Reference only

SS-10/S-2050

ROTARY SELECTOR SWITCHES

OUTLINE DIMENSIONS

Unless otherwise specified, tolerance: ± 0.3 (Unit: mm)

SS-10-15SP-E

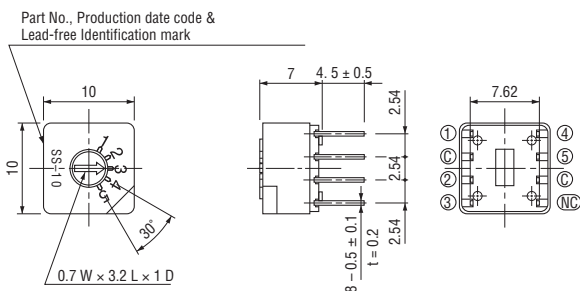

SS-10-15SP-L-E

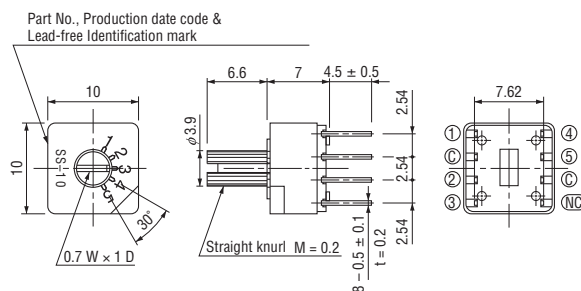

SS-10-16SP-AE

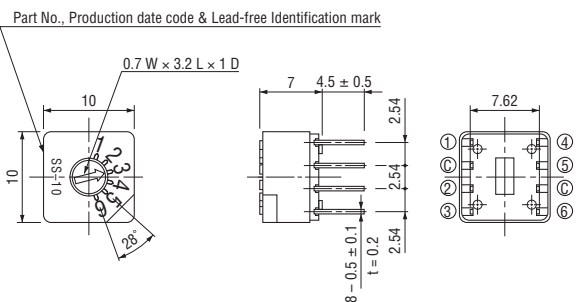

SS-10-16SP-L-AE

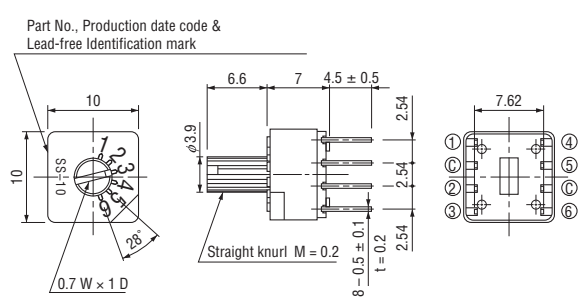

SS-10-16NP-E

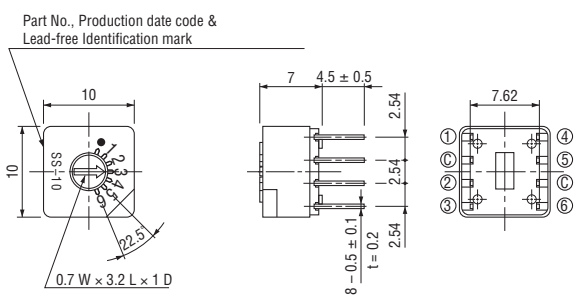

SS-10-16NP-L-E

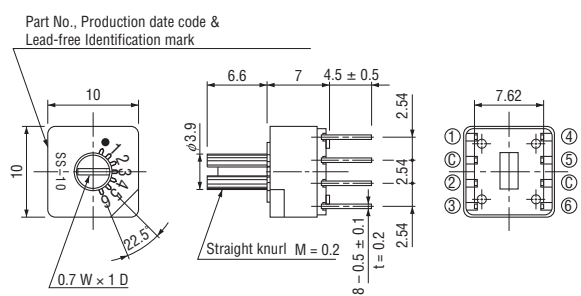

SS-10-23NP-E

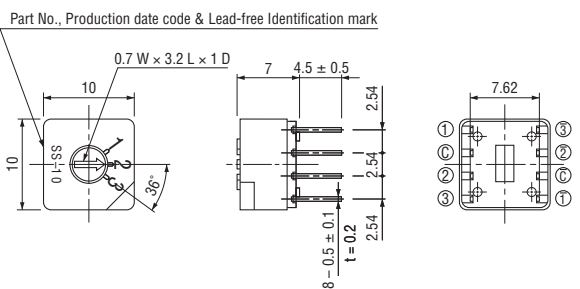

SS-10-23NP-L-E

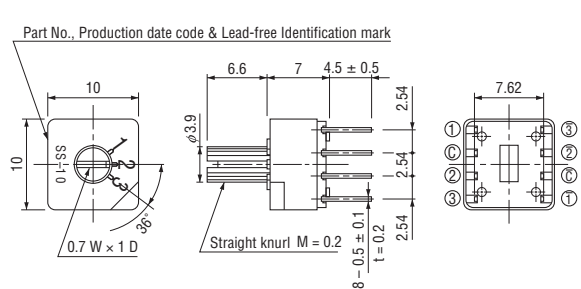

SS-10/S-2050

ROTARY SELECTOR SWITCHES

OUTLINE DIMENSIONS

Unless otherwise specified, tolerance: ± 0.3 (Unit: mm)

● S-2050

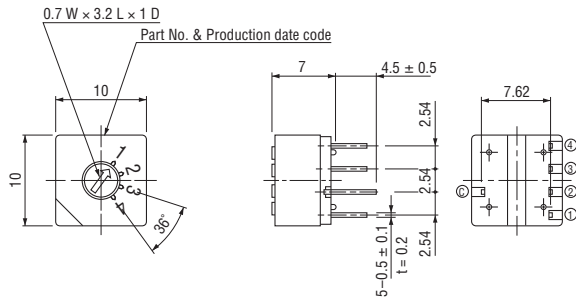

● S-2150

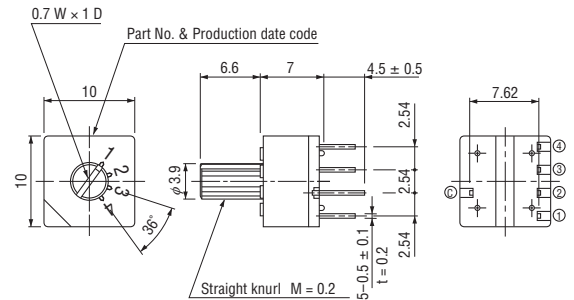

● S-2051

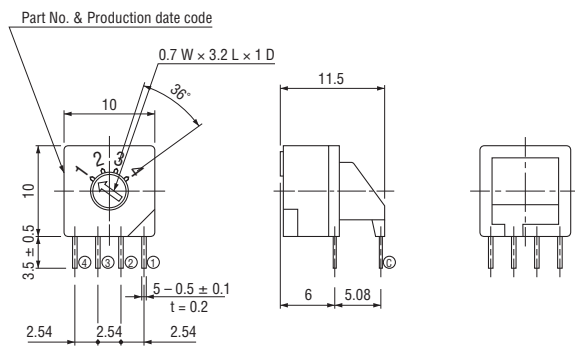

● S-2151

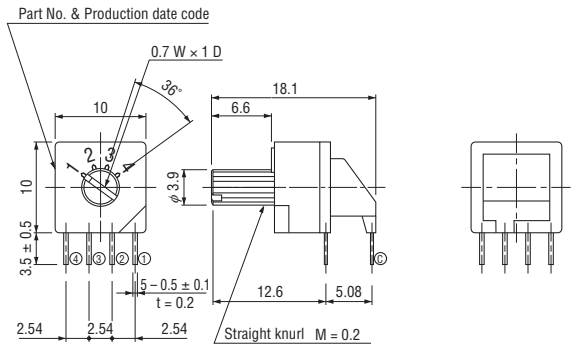

SS-10/S-2050

ROTARY SELECTOR SWITCHES

SWITCHES WITH KNOB AS EXTENDED SHAFT

(Unit: mm)

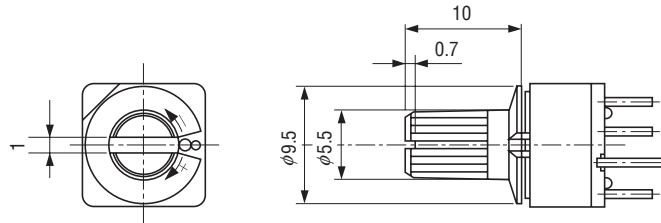
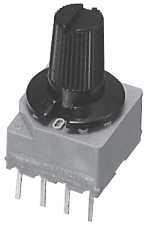

The large knob is common to S-1000A, S-2000A, SA-5000, and SS-10 series.

※ Knob can't be detached due to being fixed. Simple knob can't be sold.

PACKAGING SPECIFICATIONS

<Tray packaging specifications>

- Tray version is packaged in 50 pcs. per tray. Orders will be accepted for units of 50 pcs., i. e., 50, 100, 150 pcs. etc.
- Tray version is boxed with 10 trays.

PACKAGING SPECIFICATIONS

<Bulk pack specifications>

- The smallest unit of bulk pack in a plastic bag is 10 pcs. per pack.
Orders will be accepted for unit of minimum 10 pcs., i.e., 10, 20, 30 pcs., etc.
- Boxing of bulk in a plastic bag is performed with 25 pcs. (standard 50 pcs.) per box.

<Note> : The switch with a large knob for manual adjustment is available as a semi-standard item.