

耐食性に優れ、しかも防滴構造 圧力スイッチ PRESSURE SWITCHES

PS85



内部構造図 INTERNAL STRUCTURE (R 1/4)

名称 Part name	材料 Material
① 継手 Fitting	SUS 316L
② ケース Housing	
③ 樹脂カバー Plastic cover	ABS (Acrylonitrile butadiene styrene) + PC (Polycarbonate)
④ ダイアフラム Stainless steel diaphragm	SUS 316L

■特長 FEATURES

- 高耐食性、防滴構造を実現
圧力受圧部に〈SUS 316L〉
本体に IP-65 (IEC 準拠)
- スイッチ出力 2 点標準装備
- 負圧～正圧まで一台で測定出来る連成圧、絶対圧タイプもラインアップ
- 用途別に継手形状を用意
R2 : R 1/4 (M 5 メネジ付)
GF : G 3/8 (先端ダイアフラムタイプ)
G2 : G 1/4 (M 5 メネジ付)

- High corrosion resistance and drip-proof construction
Pressure port attachment made of SUS 316L
Proven IP-65 grade gauge body (IP-65 in accordance with IEC)
- Standard product provides two switch outputs
- Absolute pressure type and compound pressure type which can control negative to positive pressure with only a single pressure gauge are all in line
- 3 standard types of joint are provided
R2 : R 1/4 with M 5 female screw
GF : G 3/8 with flash diaphragm
G2 : G 1/4 with M 5 female screw

■型式表示 MODEL NUMBER DESIGNATION

PS85 - 102 R - N1 R2

シリーズ名 Series name	PS85	-	102	R	-	N1	R2	継手形状 Fitting
指示方式 Pressure reference	定格圧力 Rated pressure range							R2 : R 1/4 (M 5 メネジ付き) R 1/4 with M 5 female screw GF : G 3/8 (先端ダイアフラム) G 3/8 with flash diaphragm G2 : G 1/4 (M 5 メネジ付き) G 1/4 with M 5 female screw
R : 連成圧 Compound	102 : - 100 ~ 100 kPa							
	352 : - 100 ~ 350 kPa							
A : 絶対圧 Absolute	103 : - 100 ~ 1000 kPa							
	102 : 0 ~ 100 kPa abs							
								スイッチ出力方式 Switch output interface
								N1 : NPN 出力 (上限、上限モード) NPN open collector (Upper and upper limit mode) N2 : NPN 出力 (上限、下限モード) NPN open collector (Upper and lower limit mode) P1 : PNP 出力 (上限、上限モード) PNP open collector (Upper and upper limit mode) P2 : PNP 出力 (上限、下限モード) PNP open collector (Upper and lower limit mode)

※ご注文に際しては、型式一覧表をご確認ください。

Please refer to the LIST OF MODEL NUMBERS when placing orders.

PS85 PRESSURE SWITCHES

■型式一覧表 LIST OF MODEL NUMBERS

継手 形状 Fitting	形 (指示方式) Pressure reference		ゲージ圧 Gauge			絶対圧 Absolute
	出力方式 Switch output	定格圧力 kPa Rated pressure range	- 100 ~ 100	- 100 ~ 350	- 100 ~ 1000	0 ~ 100 (abs)
R2 (R 1/4)	NPN (上限、上限モード) NPN (Upper and upper limit mode)		PS85-102R-N1R2	PS85-352R-N1R2	PS85-103R-N1R2	PS85-102A-N1R2
	NPN (上限、下限モード) NPN (Upper and lower limit mode)		PS85-102R-N2R2	PS85-352R-N2R2	PS85-103R-N2R2	PS85-102A-N2R2
	PNP (上限、上限モード) PNP (Upper and upper limit mode)		PS85-102R-P1R2	PS85-352R-P1R2	PS85-103R-P1R2	PS85-102A-P1R2
	PNP (上限、下限モード) PNP (Upper and lower limit mode)		PS85-102R-P2R2	PS85-352R-P2R2	PS85-103R-P2R2	PS85-102A-P2R2
GF (G 3/8)	NPN (上限、上限モード) NPN (Upper and upper limit mode)		PS85-102R-N1GF	PS85-352R-N1GF	PS85-103R-N1GF	PS85-102A-N1GF
	NPN (上限、下限モード) NPN (Upper and lower limit mode)		PS85-102R-N2GF	PS85-352R-N2GF	PS85-103R-N2GF	PS85-102A-N2GF
	PNP (上限、上限モード) PNP (Upper and upper limit mode)		PS85-102R-P1GF	PS85-352R-P1GF	PS85-103R-P1GF	PS85-102A-P1GF
	PNP (上限、下限モード) PNP (Upper and lower limit mode)		PS85-102R-P2GF	PS85-352R-P2GF	PS85-103R-P2GF	PS85-102A-P2GF
G2 (G 1/4)	NPN (上限、上限モード) NPN (Upper and upper limit mode)		PS85-102R-N1G2	PS85-352R-N1G2	PS85-103R-N1G2	PS85-102A-N1G2
	NPN (上限、下限モード) NPN (Upper and lower limit mode)		PS85-102R-N2G2	PS85-352R-N2G2	PS85-103R-N2G2	PS85-102A-N2G2
	PNP (上限、上限モード) PNP (Upper and upper limit mode)		PS85-102R-P1G2	PS85-352R-P1G2	PS85-103R-P1G2	PS85-102A-P1G2
	PNP (上限、下限モード) PNP (Upper and lower limit mode)		PS85-102R-P2G2	PS85-352R-P2G2	PS85-103R-P2G2	PS85-102A-P2G2

※ご注文に際しては、上記型式をご確認ください。
Verify the above model numbers when placing orders.

■標準仕様 STANDARD SPECIFICATIONS

● 特記ない場合、周囲温度 25 ± 5 °C、駆動電圧 12 V DC で規定します。
Unless otherwise specified, the specs are defined at an ambient temperature of 25±5 °C and excitation voltage of 12 V DC.

項目 Item	型式 Model number	PS85			
		102R	352R	103R	102A
形 (指示方式) Pressure reference		ゲージ圧 Gauge			絶対圧 Absolute
定格圧力 / 定格圧力範囲 Rated pressure range	kPa	- 100 ~ 100	- 100 ~ 350	- 100 ~ 1000	100 (abs)
最大圧力 Maximum pressure	kPa	200	700	2000	200 (abs)
破壊圧力 Break-down pressure	kPa	300	1050	3000	300 (abs)
動作温度 Operating temp. range	°C	- 20 ~ 80			
補償温度 Compensated temp. range	°C	0 ~ 50			
動作湿度 Operating humidity	%RH	35 ~ 85 (結露ないこと No condensation)			
保存温度 Storage temp.	°C	- 20 ~ 80 (大気圧、湿度 65 %RH 以下 Atmospheric pressure, humidity 65 %RH maximum)			
適用媒体 Pressure medium		SUS 316L を腐食させない気体及び液体 Corrosive gases/liquids compatible with SUS 316L			
絶縁抵抗 Insulation resistance	MΩ minimum	100 (500 V DC)			

PS85

PRESSURE SWITCHES

■標準仕様 STANDARD SPECIFICATIONS

- 特記ない場合、周囲温度 25 ± 5 °C、駆動電圧 12 V DC で規定します。
Unless otherwise specified, the specs are defined at an ambient temperature of 25±5 °C and excitation voltage of 12 V DC.

項目 Item	型式 Model number	PS85			
		102R	352R	103R	102A
一般仕様 General specifications	耐電圧 Dielectric strength	800 V AC, 60 s (リーク電流 1 mA 以下 Leakage current 1 mA maximum)			
	封入液 Sealed liquid	シリコンオイル Silicone oil			
	圧力ポート Pressure port	R 1/4、G 3/8 (フラッシュダイアフラム Flash diaphragm)、G 1/4 ※ 1			
	質量 Net weight	g	R2 : Approx. 165, GF : Approx. 180, G2 : Approx. 170		
	保護構造 Drip-proof structure		IP-65		
電源 Power	駆動電圧 Supply voltage	V DC	10.8 ~ 30 (リップル含む Including ripple percentage)		
	消費電流 Consumption current	maximum	20 mA		
スイッチ出力 Switch output	出力点数 No. of outputs		2		
	出力方式 Output interface		オープンコレクタ (NPN/PNP) Open collector output (NPN or PNP)		
	設定方式 Setting method		トリマによる可変式 Adjustable by VR		
	設定範囲 Adjustable range		0 ~ 100 %	0 ~ 108 %	
	動作モード Output mode		上限、上限モード/上限、下限モード Upper and upper limite mode/Upper and lower limite mode		
	出力表示 Display		SW1 : 赤色 LED 点灯、SW2 : 緑色 LED 点灯 SW1 : Red LED ON, SW2 : Green LED ON		
	精度 Accuracy (Reference temp.: 25 °C)	0 ~ 50 °C (基準温度 25 °C) %F.S.	± 3		
	応差 Hysteresis	%F.S. maximum	2		
	スイッチ容量 Switching capacity		30 V DC 100 mA 以下		
	残留電圧 Residual voltage	V	0.8 (NPN), 1.2 (PNP)		
応答速度 Response	ms	Approx. 2			

- ※ 1 ○ リング付属 (G 3/8 : P18、G 1/4 : P15)
An "O" ring is provided as accessory. (G 3/8 : P18, G 1/4 : P15)

■環境特性 ENVIRONMENTAL CHARACTERISTICS

試験項目 Test item	試験方法 (条件 25 ± 5 °C) Test conditions (At 25 ± 5 °C)	変動量 Permissible change
振動 Vibration	10 ~ 500 Hz, 1.5 mm maximum/98.1 m/s ² , 3 directions for 2 hours each	スイッチ出力設定値最大 ± 1 %F.S. Switch output setting: ± 1 %F.S. maximum
衝撃 Shock	490 m/s ² 3 directions for 3 times each	
圧力サイクル Pressure cycling	定格圧力 / 定格圧力範囲 10 ⁶ cycles Rated pressure range	
耐湿性 Moisture resistance	40 °C, 90 ~ 95 %RH, 240 hrs.	

外形寸法図 OUTLINE DIMENSIONS

Unless otherwise specified, tolerance : ± 0.5 (Unit: mm)

● 継手形状 R2 (R 1/4) タイプ Configurations of joint R2 (R 1/4) type

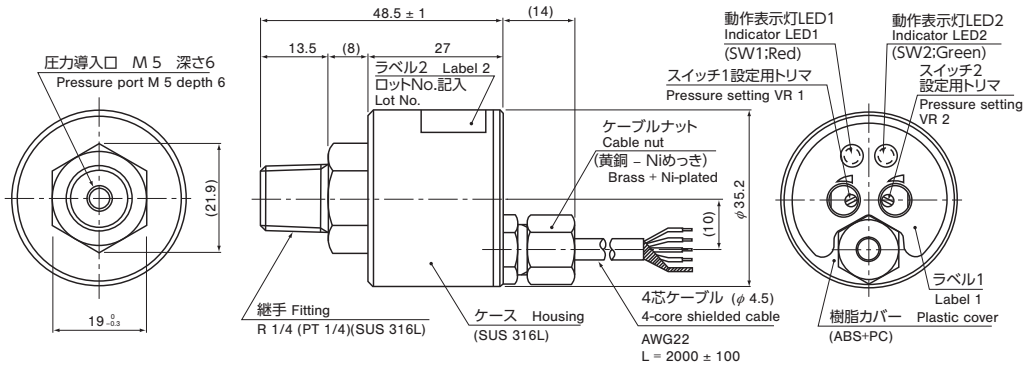

● 継手形状 GF (G 3/8) タイプ Configurations of joint GF (G 3/8) type

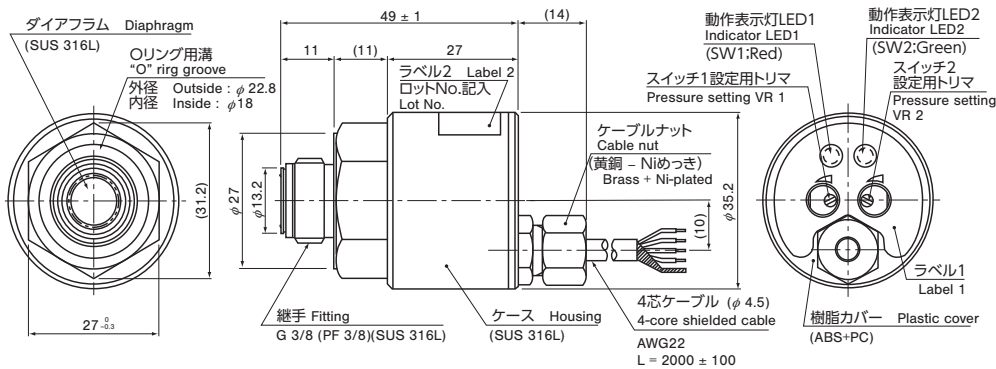

⚠ ステンレスダイアフラム部は、指や個体物等で押したりしますと、ダイアフラム面が変形したり破壊することがありますので、ご注意ください。
Extra care should be taken with the diaphragm part. Do not touch the diaphragm directly to avoid damaging the diaphragm.

● 継手形状 G2 (G 1/4) タイプ Configurations of joint G2 (G 1/4) type

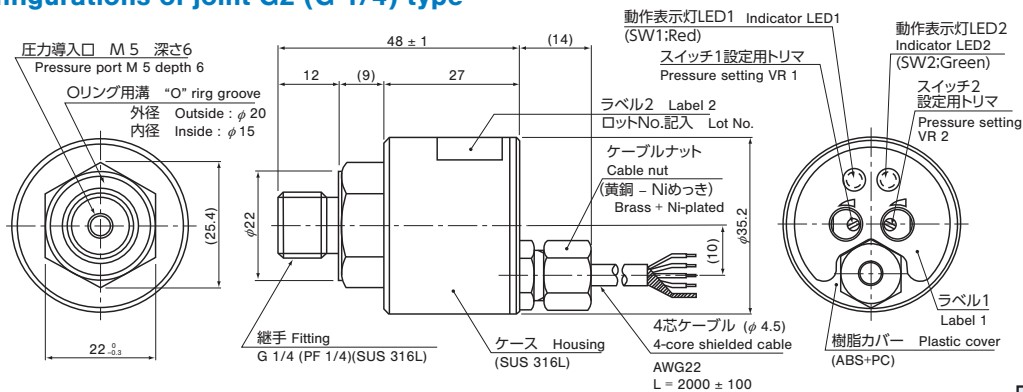

Wire color	Connection
Brown	Power ⊕
Black	Switch output 1
White	Switch output 2
Blue	Common
Shield	Fitting

PS85 PRESSURE SWITCHES

■スイッチ出力動作 SWITCH OUTPUT SCHEMATICS

● PS85-***R-1**

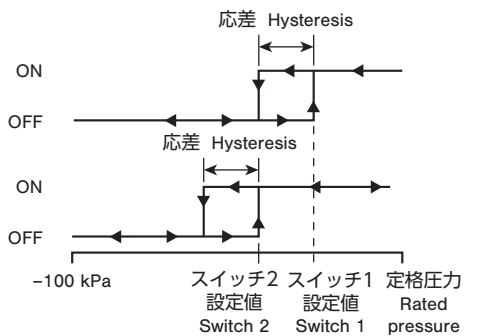

● PS85-102A-1**

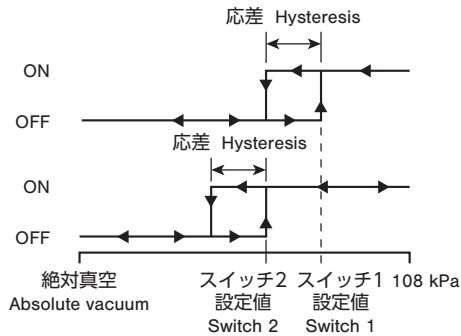

● PS85-***R-2**

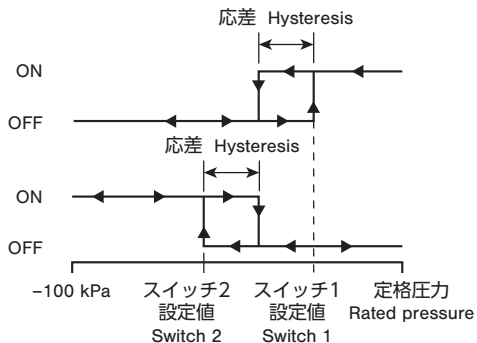

● PS85-102A-2**

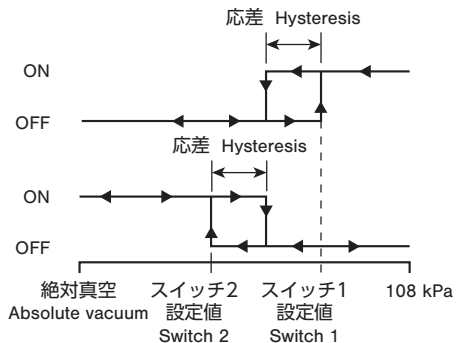

■内部電気回路 INTERNAL ELECTRICAL SCHEMATICS

● NPN

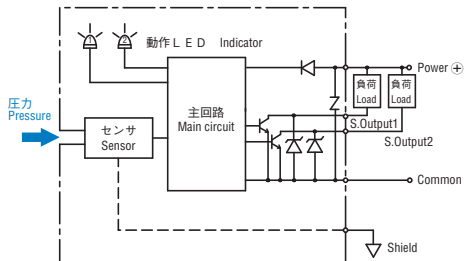

● PNP

